



## Filterless 6W Class- F Mono Audio Amplifier

### integrated Non-Crack Noise function

#### General Description

The LPA2176 is a 6W, class-F mono audio amplifier integrated Class AB/D optional mode and unique Non-Crack Noise (NCN) function. It is capable of delivering 6.6watts of continuous average power to a 2Ω BTL load with less than 10% distortion (THD) from a 5.5V DC power supply. It offers low THD+N, allowing it to achieve high-quality Power Supply sound reproduction. The new filterless architecture allows the device to drive the speaker directly requiring no low-pass output filters, thus to save the system cost and PCB area. The LPA2176 is available in ESOP-8.

#### Order Information

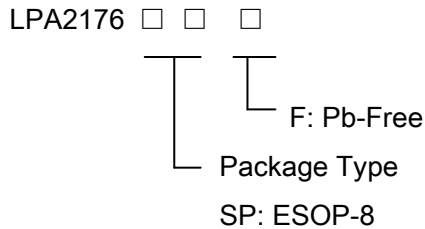

#### Applications

- ✧ Portable Bluetooth Speaker
- ✧ Cellular and Smart mobile phone
- ✧ Square Speaker

#### Features

- ◆ The unique Non-Crack Noise (NCN) function
- ◆ Shutdown current:<5uA
- ◆ 600KHz fixed frequency switching for amplifier
- ◆ 5.5W Output at 10% THD with a 2 Ω Load and 5V VDD for amplifier
- ◆ 4.4W Output at 1% THD with a 2 Ω Load and 5V VDD for amplifier
- ◆ 4.0W Output at 10% THD with a 4 Ω Load and 5.5V VDD for amplifier
- ◆ Short Circuit Protection
- ◆ Filterless,Low Quiescent Current and Low EMI
- ◆ Amplifier Efficiency up to 90%
- ◆ Free LC filter digital modulation, direct-drive speakers
- ◆ Thermal Shutdown
- ◆ Few External Components to Save the Space and cost
- ◆ Pb-Free Package

#### Marking Information

Device	Marking	Package	Shipping
LPA2176	LPS LPA2176 YWX	ESOP-8	3K/REEL
Y: Y is year code. W: W is week code. X: X is series number.			



### Typical Application Circuit

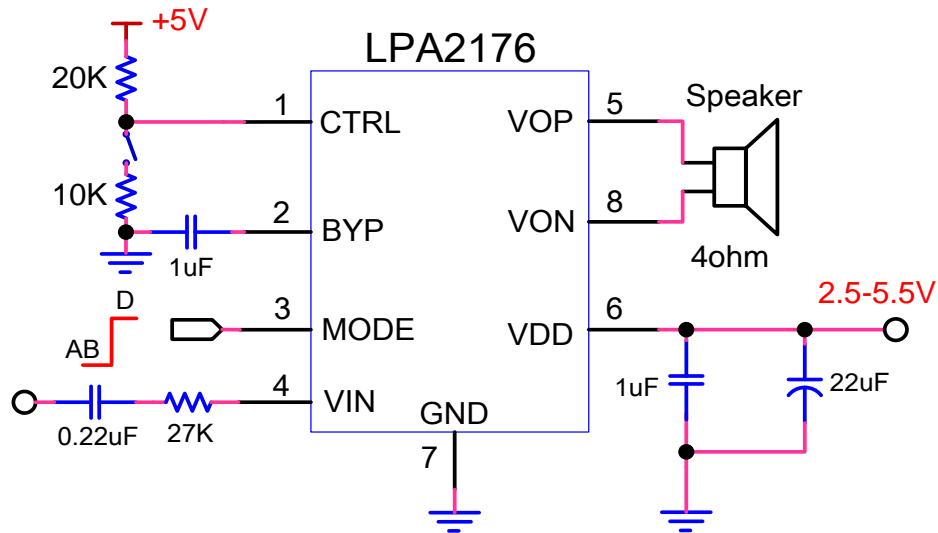

Figure 1. Typical Application Circuit

### Functional Pin Description

Package Type	Pin Configurations
ESOP-8	<p>CTRL 1      8 VON        BYP 2      7 GND        MODE 3      6 VDD        VIN 4      5 VOP</p>

Figure 2. The Pin Configurations



## Functional Pin Description

Pin	PIN No.	DESCRIPTION
CTRL	1	Shutdown and NCN control. When the CTRL pin voltage is below 0.5V, the chip is turned off, and when the CTRL pin voltage is higher than 0.7V, the chip enable. When the CTRL pin voltage is greater than 0.9V and less than 0.4VDD, the chip enter NCN mode.
BYP	2	Bypass pin. Connect a 1uF capacitor between this pin and GND.
MODE	3	Mode control pin. High voltage with Class_D mode and low voltage with Class_AB mode.
IN	4	Input of amplifier.
VOP	5	Positive output of signal.
VDD	6	Voltage supply pin.
GND	7	Power ground.
VON	8	Negative output of signal.

## Absolute Maximum Ratings

Supply Input Voltage range----- 2.3V to 6.5V  
 Input voltage ----- -0.3V to VDD+0.3V  
 Lead Temperature (Soldering, 10 sec.) ----- 260°C  
 Storage Temperature Range ----- -65°C to 150°C  
 Operation Junction Temperature Range ----- -40°C to 125°C  
 Operation Ambient Temperature Range----- -40°C to 85°C  
 Maximum Junction Temperature Range----- 150°C  
 Maximum Power Dissipation ( $P_D, T_A < 40^\circ\text{C}$ ) ----- 2.6W  
 Thermal resistance (junction to ambient) ----- 45°C/W



## Electrical Characteristics For Amplifier

(VDD = 5V, GAIN = 20dB, RL=4Ω , TA = 25° C, Class D Mode, unless otherwise specified)

Parameter	Symbol	Test Conditions	Min	Typ		Max	Units	
				Class-D	Class-AB			
Supply power	VIN		2.5			5.5	V	
Output power	Po	THD+N=10%, f=1KHz,RL=4Ω	VDD=5.5V		4	3.9		W
			VDD=5.0V		3.3	3.2		
			VDD=4.2V		2.3	2.3		
			VDD=3.7V		1.75	1.75		
		THD+N=1%, f=1KHz,RL=4Ω	VDD=5.5V		3.2	3.2		
			VDD=5.0V		2.7	2.6		
			VDD=4.2V		1.8	1.8		
		THD+N=10%, f=1KHz,RL=2Ω	VDD=3.7V		1.4	1.4		
			VDD=5.5V		6.6	6.2		
			VDD=5.0V		5.5	5.3		
			VDD=4.2V		3.7	3.6		
		Power supply ripple rejection	PSRR	INPUT ac-grounded with CIN=0.47uF, VDD=6.0V	f=100HZ		75	
f=1KHz					50			
Signal-to-noise ratio	SNR	VDD=5V,Class_AB,f=1KHz			93		dB	
		VDD=5V,Class_D,f=1KHz			92			
Output noise	VN	INPUT ac-grounded with CIN=0.47uF, VDD=5.0V			80		μV	
Efficiency	η	RL=4Ω, Po=3.2W , f=1KHz			90		%	
Switching frequency	F <sub>SW</sub>	VDD=2.5V to 5.5V			600		kHz	
Output offset voltage	V <sub>OS</sub>	VDD=5.0V, V <sub>SD</sub> =0V			3.5	3	mV	
Shutdown current	I <sub>LEAK</sub>	V <sub>SD</sub> =VDD=5.0V			2		uA	
Quiescent current	I <sub>Q</sub>	VDD=5.0V , No load			4	6.8	mA	
Threshold voltage of class D	V <sub>MOD_D</sub>	VDD=2.5-5.5V		0.7			V	
Threshold voltage of class AB	V <sub>MOD_AB</sub>	VDD=2.5-5.5V				0.5		
Threshold voltage of CTRL pin	V <sub>SD_H</sub>	VDD=2.5-5.5V		0.7				
	V <sub>SD_L</sub>	VDD=2.5-5.5V				0.5		
The Non-Crack Noise mode voltage	V <sub>NCN</sub>	VDD=2.5-5.5V		0.9		0.4VDD		



# Typical Operating Characteristic

## Audio Precision

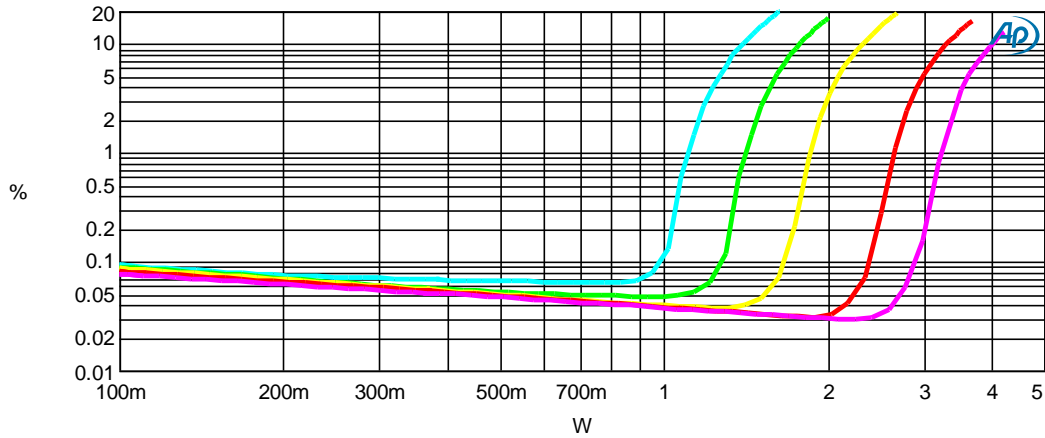

Sweep	Trace	Color	Line Style	Thick	Data	Axis	Comment
1	1	Cyan	Solid	3	Analyzer.THD+N Ratio A	Left	3.3V,4ohm,AB
2	1	Green	Solid	3	Analyzer.THD+N Ratio A	Left	3.7V,4ohm,AB
3	1	Yellow	Solid	3	Analyzer.THD+N Ratio A	Left	4.2V,4ohm,AB
4	1	Red	Solid	3	Analyzer.THD+N Ratio A	Left	5V,4ohm,AB
5	1	Magenta	Solid	3	Analyzer.THD+N Ratio A	Left	5.5V,4ohm,AB

Figure 3. THD+N VS Output Power, Freq=1kHz, class AB, RL=4Ω

## Audio Precision

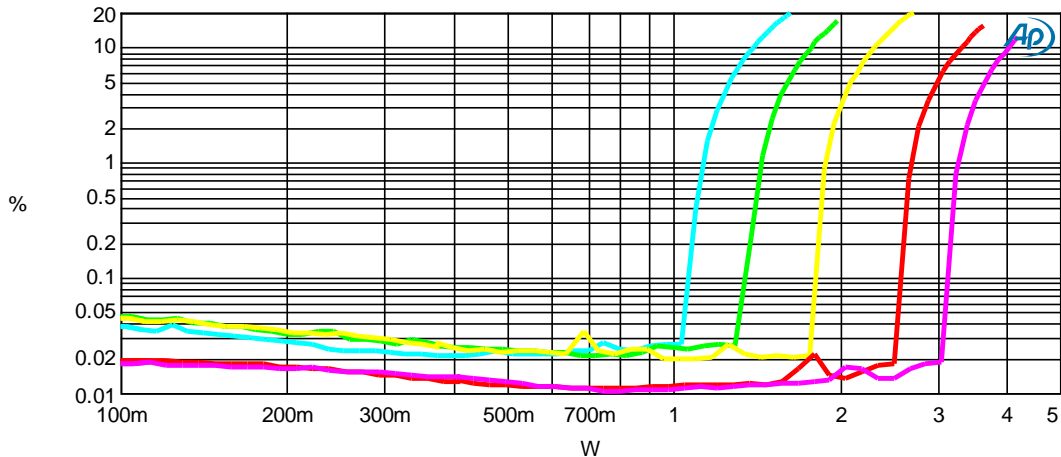

Sweep	Trace	Color	Line Style	Thick	Data	Axis	Comment
1	1	Cyan	Solid	3	Analyzer.THD+N Ratio A	Left	3.3V,4ohm,D
2	1	Green	Solid	3	Analyzer.THD+N Ratio A	Left	3.7V,4ohm,D
3	1	Yellow	Solid	3	Analyzer.THD+N Ratio A	Left	4.2V,4ohm,D
4	1	Red	Solid	3	Analyzer.THD+N Ratio A	Left	5V,4ohm,D
5	1	Magenta	Solid	3	Analyzer.THD+N Ratio A	Left	5.5V,4ohm,D

Figure 4. THD+N VS Output Power, class D, Freq=1kHz, RL=4Ω, NCN OFF



Audio Precision

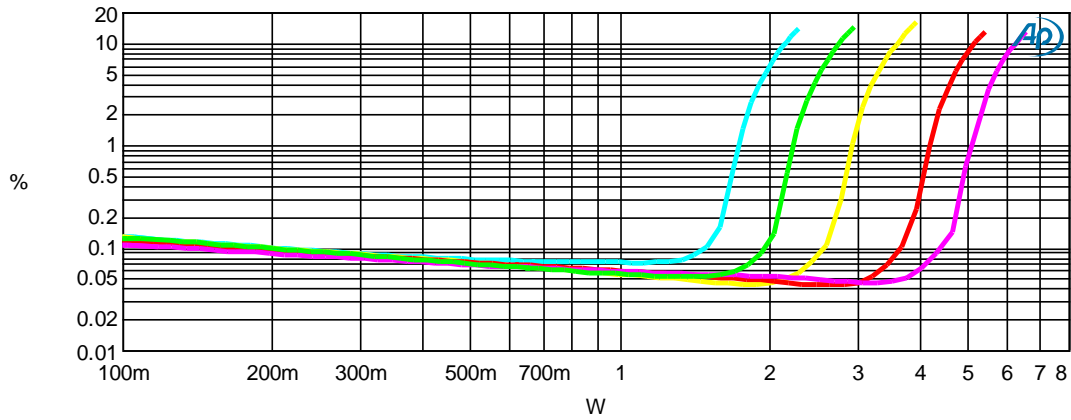

Sweep	Trace	Color	Line Style	Thick	Data	Axis	Comment
1	1	Cyan	Solid	3	Analyzer.TH <sub>D</sub> +N Ratio A	Left	3.3V,2ohm,class AB
2	1	Green	Solid	3	Analyzer.TH <sub>D</sub> +N Ratio A	Left	3.7V,2ohm,class AB
3	1	Yellow	Solid	3	Analyzer.TH <sub>D</sub> +N Ratio A	Left	4.2V,2ohm,class AB
4	1	Red	Solid	3	Analyzer.TH <sub>D</sub> +N Ratio A	Left	5V,2ohm,class AB
5	1	Magenta	Solid	3	Analyzer.TH <sub>D</sub> +N Ratio A	Left	5.5V,2ohm,class AB

Figure 5. THD+N VS Output Power, Freq=1kHz, class AB, RL=2Ω

Audio Precision

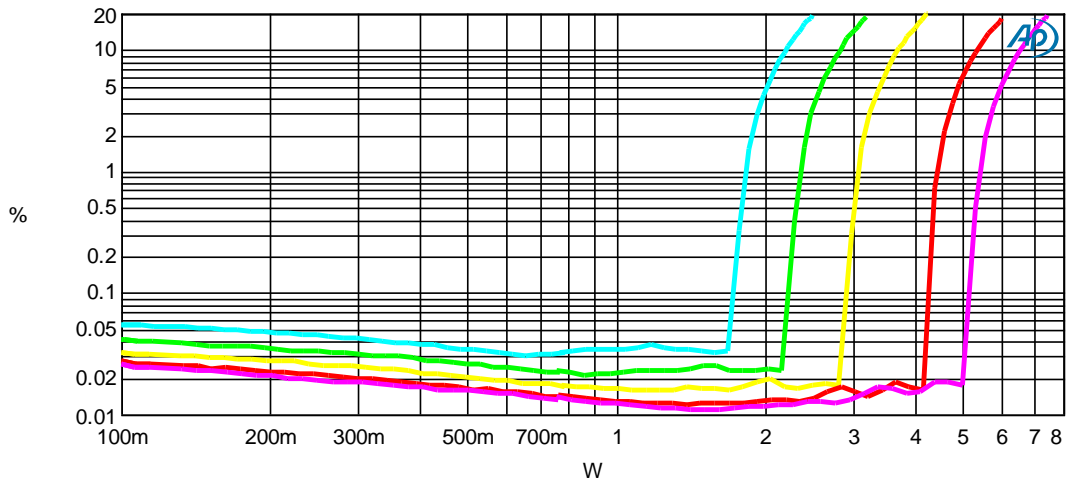

Sweep	Trace	Color	Line Style	Thick	Data	Axis	Comment
1	1	Cyan	Solid	3	Analyzer.TH <sub>D</sub> +N Ratio A	Left	3.3V,2ohm,class D
2	1	Green	Solid	3	Analyzer.TH <sub>D</sub> +N Ratio A	Left	3.7V,2ohm,class D
3	1	Yellow	Solid	3	Analyzer.TH <sub>D</sub> +N Ratio A	Left	4.2V,2ohm,class D
4	1	Red	Solid	3	Analyzer.TH <sub>D</sub> +N Ratio A	Left	5V,2ohm,class D
5	1	Magenta	Solid	3	Analyzer.TH <sub>D</sub> +N Ratio A	Left	5.5V,2ohm,class D

Figure 6. THD+N VS Output Power, class D, Freq=1kHz, RL=2Ω, NCN OFF



Audio Precision

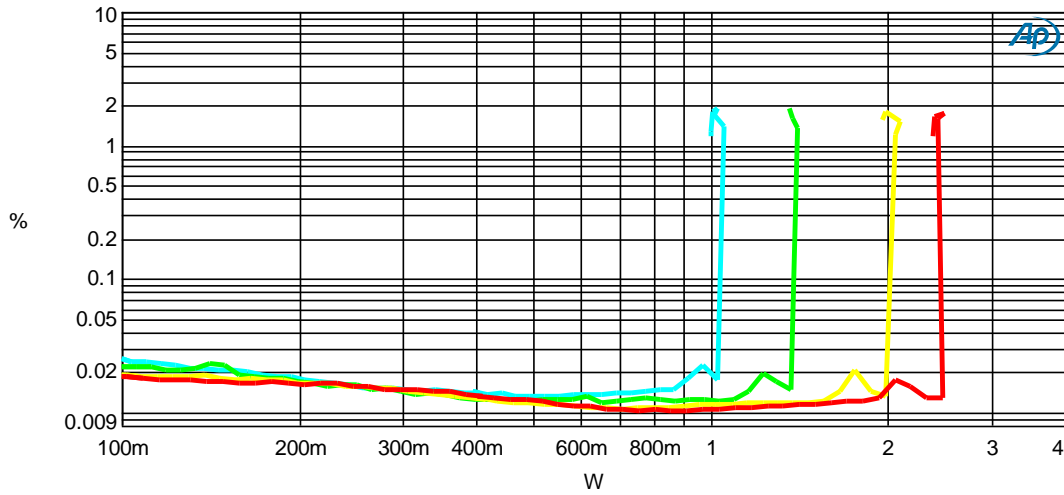

Sweep	Trace	Color	Line Style	Thick	Data	Axis	Comment
1	1	Cyan	Solid	3	Analyzer.TH+N Ratio A	Left	3.7V,4ohm,class D
2	1	Green	Solid	3	Analyzer.TH+N Ratio A	Left	4.2V,4ohm,class D
3	1	Yellow	Solid	3	Analyzer.TH+N Ratio A	Left	5V,4ohm,class D
4	1	Red	Solid	3	Analyzer.TH+N Ratio A	Left	5.5V,4ohm,class D

Figure 7. THD+N VS Output Power, class D, Freq=1kHz, RL=4Ω, NCN ON

Audio Precision

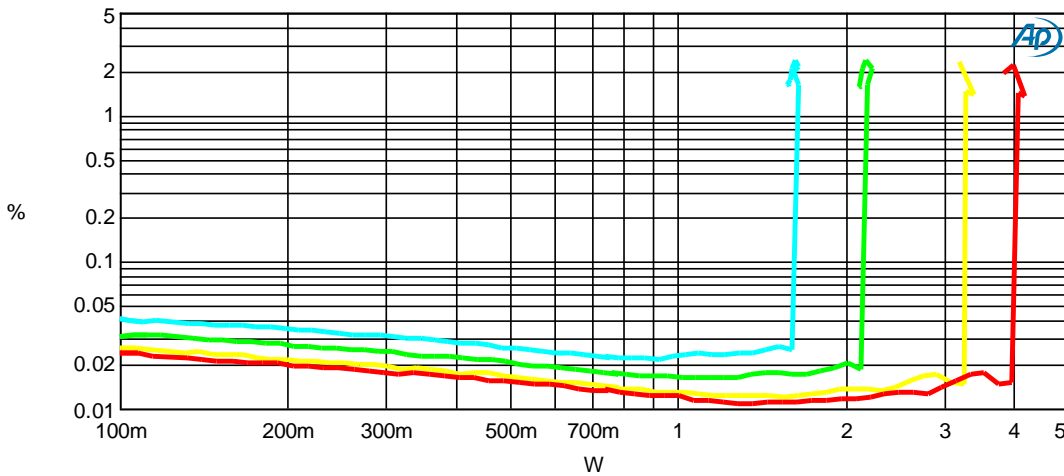

Sweep	Trace	Color	Line Style	Thick	Data	Axis	Comment
1	1	Cyan	Solid	3	Analyzer.TH+N Ratio A	Left	3.7V,2ohm,class D
2	1	Green	Solid	3	Analyzer.TH+N Ratio A	Left	4.2V,2ohm,class D
3	1	Yellow	Solid	3	Analyzer.TH+N Ratio A	Left	5V,2ohm,class D
4	1	Red	Solid	3	Analyzer.TH+N Ratio A	Left	5.5V,2ohm,class D

Figure 8. THD+N VS Output Power, class D, Freq=1kHz, RL=2Ω, NCN ON



Audio Precision

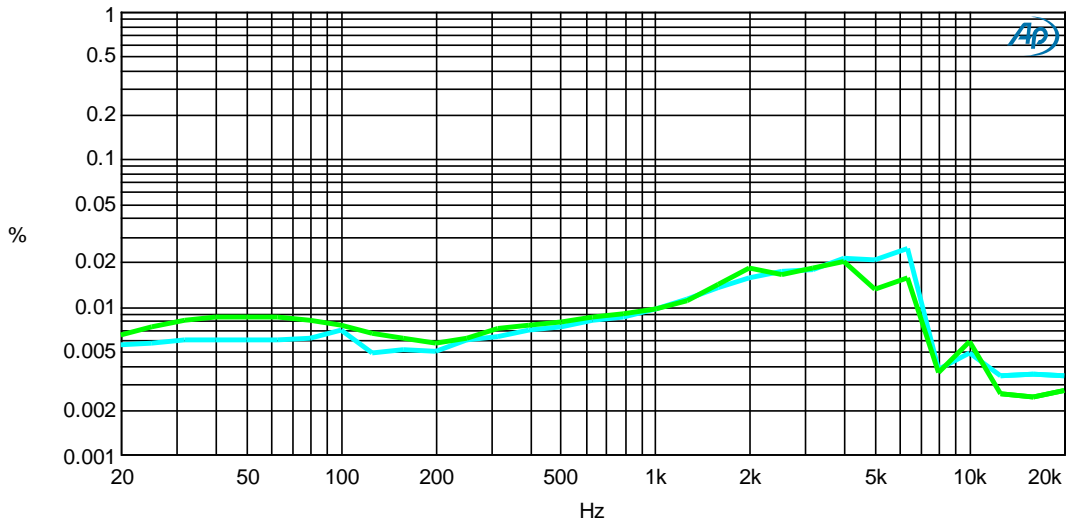

Sweep	Trace	Color	Line Style	Thick	Data	Axis	Comment
1	1	Cyan	Solid	3	Analyzer.TH+D+N Ratio A	Left	5V,4ohm,1W
2	1	Green	Solid	3	Analyzer.TH+D+N Ratio A	Left	5V,4ohm,2W

Figure 9. THD VS Frequency, Class D, RL=4Ω

Audio Precision

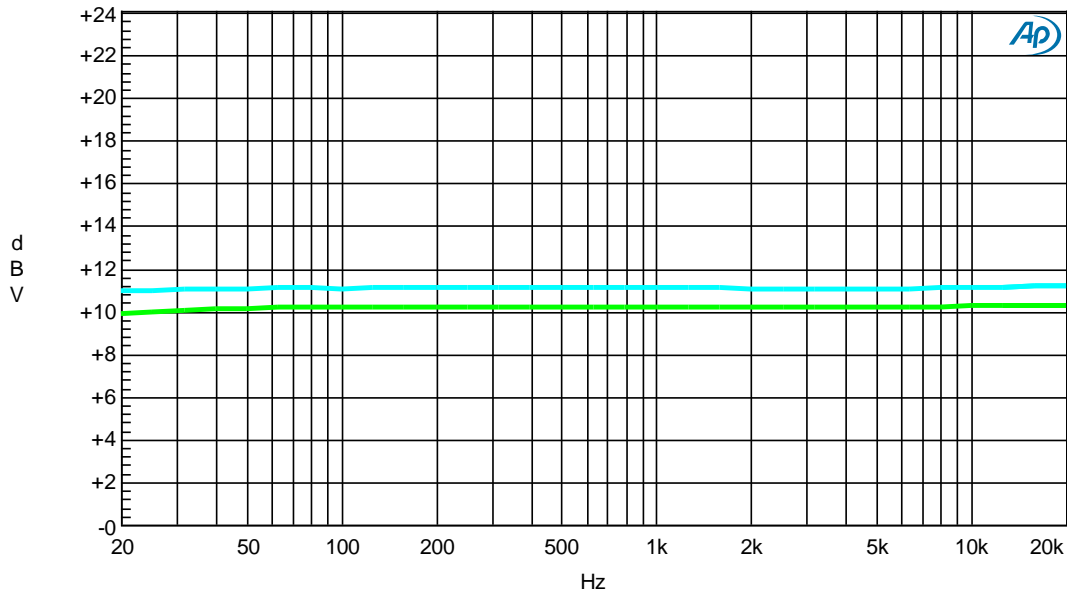

Sweep	Trace	Color	Line Style	Thick	Data	Axis	Comment
1	1	Cyan	Solid	3	Analyzer.Level A	Left	5V,4ohm, THD=10%
2	1	Green	Solid	3	Analyzer.Level A	Left	5V,4ohm, THD=1%

Figure 10. Output Amplitude VS Frequency, Class D, RL=4Ω





## Applications Information

### The Non-Crack Noise (NCN) function

The LPA2176 integrated Non-Crack Noise function. Through the CTRL pin set, you can enter the NCN working mode. The amplifier automatically detects the output clipping distortion and automatically adjusts the gain of the amplifier to achieve the distortion prevention effect. As shown in the following figure:

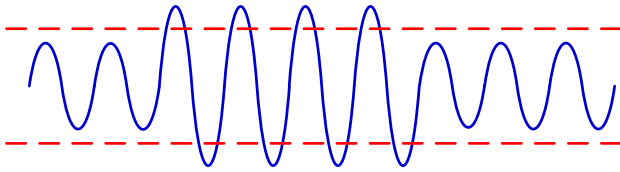

Figure 11. Assume that the audio output signal is not limited by the power supply voltage

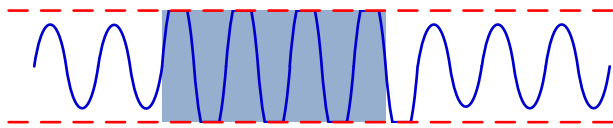

Figure 12. Audio output signal in normal working mode

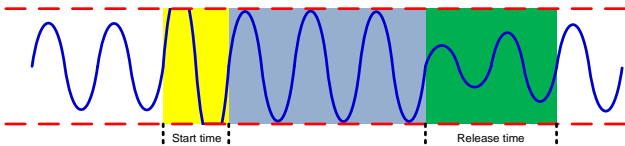
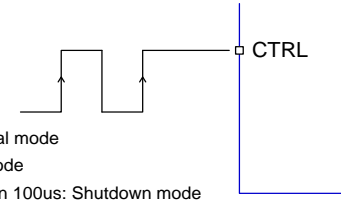

Figure 13. Audio output signal in NCN working mode

The LPA2176 can work on NCN working mode through software or hardware settings. The LPA2176 supports a line of pulses that control the LPA2176 through the CTRL pin and into different modes of operation. The first rising edge works in the ordinary mode. The second rising edges operate in the anti distortion mode. CTRL pin is pulled low and remains above 100US chip into shutdown (SHUTDOWN) mode. If you want to re-enter, one of these two modes must be reset. As shown in the following figure:



The first rising edge: Normal mode  
The second rising: NCN mode  
The low level is greater than 100us: Shutdown mode

Figure 14. The LPA2176 sets the working mode with software

The line pulse high level width ( $T_{HI}$ ) that is added to the CTRL pin requires  $1\mu s < T_{HI} < 12\mu s$ . The low level width ( $T_{LO}$ ) requires  $1\mu s < T_{LO} < 12\mu s$ . Entering the Shutdown mode, the low hold time ( $T_{OFF}$ ) requires  $T_{OFF} > 100\mu s$ . The timing diagram is as follows:

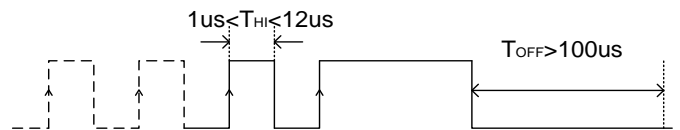

Figure 15. sequence diagram of line pulse

The LPA2176 also supports hardware setup working mode. Through the CTRL pin level settings, the LPA2176 into different modes of operation. The CTRL pin voltage between  $0.4V_{DD} - V_{DD}$  and the LPA2176 in normal mode; the CTRL pin voltage between  $0.9V - 0.4V_{DD}$  and the LPA2176 works in the NCN mode; CTRL pin voltage below  $0.5V$ , LPA2176 to SHUTDOWN. As shown in the following figure: if  $V_{DD} = 5.0V$ ,  $R1 = 0$ , the CTRL pin level is  $V_{DD} = 5.0V$ . The chip operates in normal mode; the CTRL pin level is  $1/3V_{DD} = 1.7V$  at  $R1 = 20k$ . The chip operates in an anti distortion mode, and the CTRL pin level is  $< 0.5V$  when the chip operates in shutdown (SHUTDOWN) mode.

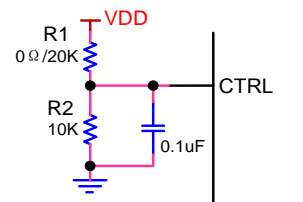

Figure 15. The LPA2176 sets the working mode with hardware



### Maximum Gain

The LPA2176 has two internal amplifier stages. The first stage's gain is externally configurable, while the second stage's is internally fixed. The closed-loop gain of the first stage is set by selecting the ratio of  $R_f$  to  $R_i$  while the second stage's gain is fixed at  $2x$ . The output of amplifier 1 serves as the input to amplifier 2, thus the two amplifiers produce signals identical in magnitude, but different in phase by  $180^\circ$ . Consequently, the differential gain for the IC is

$$A_{VD} = 20 \cdot \log [2 \cdot R_f / (R_i + 7.6)]$$

The LPA2176 sets maximum:

$R_f = 130 \text{ k} \Omega \pm 10\%$	class-AB
$R_f = 120 \text{ k} \Omega \pm 10\%$	class-D

### CTRL Pin operation

In order to reduce power consumption while not in use, the LPA2176 contains shutdown circuitry to turn off the amplifier's bias circuitry. This shutdown feature turns the amplifier off when logic low is applied to the CTRL pin. When the CTRL pin voltage is below  $0.5V$ , the chip is turned off, and when the CTRL pin voltage is higher than  $0.7V$ , the chip enable. When the CTRL pin voltage is greater than  $0.9V$  and less than  $0.4V_{DD}$ , the chip enter NCN mode.

### Power supply decoupling

The LPA2176 is a high performance CMOS audio amplifier that requires adequate power supply decoupling to ensure the output THD and PSRR a low as possible. Power supply decoupling affects low frequency response. Optimum decoupling is achieved by using two capacitors of different types targeting to different types of noise on the power supply leads. For higher frequency transients, spikes, or digital hash on the line, a good low equivalent-series-resistance (ESR) ceramic capacitor, typically  $1.0\mu F$ , works best,

placing it as close as possible to the device  $V_{DD}$  terminal. For filtering lower-frequency noise signals, a large capacitor of  $20\mu F$  (ceramic) or greater is recommended, placing it near the audio power amplifier.

### Input Capacitor ( $C_i$ )

$C_i$  for boost. Large input capacitors are both expensive and space hungry for portable designs. Clearly, a certain sized capacitor is needed to couple in low frequencies without severe attenuation. But in many cases the speakers used in portable systems, whether internal or external, have little ability to reproduce signals below  $100\text{Hz}$  to  $150\text{Hz}$ . In the typical application, an input capacitor  $C_i$  is required to allow the amplifier to bias the input signal to the proper dc level for optimum operation. Thus, using a large input capacitor may not increase actual system performance. In this case, input capacitor ( $C_i$ ) and input resistance ( $R_i$ ) of the amplifier form a high-pass filter with the corner frequency determined by equation below,

$$f_c = \frac{1}{2\pi R_i C}$$

### Analog Reference Bypass Capacitor (CBYP)

In addition to system cost and size, click and pop performance is affected by the size of the input coupling capacitor,  $C_i$ . A larger input coupling capacitor requires more charge to reach its quiescent DC voltage (nominally  $1/2 V_{DD}$ ). This charge comes from the internal circuit via the feedback and is apt to create pops upon device enable. Thus, by minimizing the capacitor size based on necessary low frequency response, turn-on pops can be minimized.

The Analog Reference Bypass Capacitor (CBYP) is the most critical capacitor and serves several important functions. During start-up or recovery from shutdown mode, CBYP determines the rate at which the amplifier starts up. The second function is to



reduce noise caused by the power supply coupling into the output drive signal. This noise is from the internal analog reference to the amplifier, which appears as degraded PSRR and THD+N. The LPA2176 incorporates circuitry designed to detect low supply voltage. When the supply voltage drops to 2.7V or below, the LPA2176 outputs are disabled, and the device comes out of this state and starts to normal function when  $VDD \geq 2.7V$ .

### Short Circuit Protection (SCP)

The LPA2176 has short circuit protection circuitry on the outputs to prevent damage to the device when output-to-output or output-to-GND short occurs. When a short circuit is detected on the outputs, the outputs are disabled immediately. If the short was removed, the device activates again.

### Over Temperature Protection

Thermal protection on the LPA2176 prevents the device from damage when the internal die temperature exceeds 140°C. There is a 15 degree tolerance on this trip point from device to device. Once the die temperature exceeds the thermal set point, the device outputs are disabled. This is not a latched fault. The thermal fault is cleared once the temperature of the die is reduced by 30°C. This large hysteresis will prevent motor boating sound well and the device begins normal operation at this point without external system intervention.

### How to reduce EMI

A simple solution is to put an additional capacitor 220pF at power supply terminal for power line. The traces from amplifier to speakers should design as

short as we can.

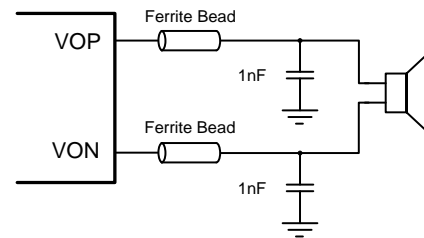

Figure 17 . Typical Ferrite Chip Bead Filter

## PCB Layout notices

- 1, In the path of the input signal plus a 103-to-ground high-frequency filter capacitor.
- 2, The power and ground and filter capacitor and bypass capacitors as close to the chip's pins, remember not to put the capacitor on the back of the board, through tiny holes through the jumper even over.
- 3, Power, ground, and a large current signal line to go to try to rough, if you want to add vias, the number of through-holes must be at least 6.
- 4, If you want to pursue as large as the effect of power, a large selection of speakers or sound chamber with low resistance (such as 3.6Ω) speakers, or added to improve the supply voltage boost circuit.
- 5, Sensitive attention to shielding the signal line, it is best to use a differential signal. Try not to interfere with the sensitive line through the signal line.
- 6, The position on the board under the amplifier chip must be added vents and large areas of exposed copper and tin to enhance heat dissipation.



## Packaging Information

### ESOP8

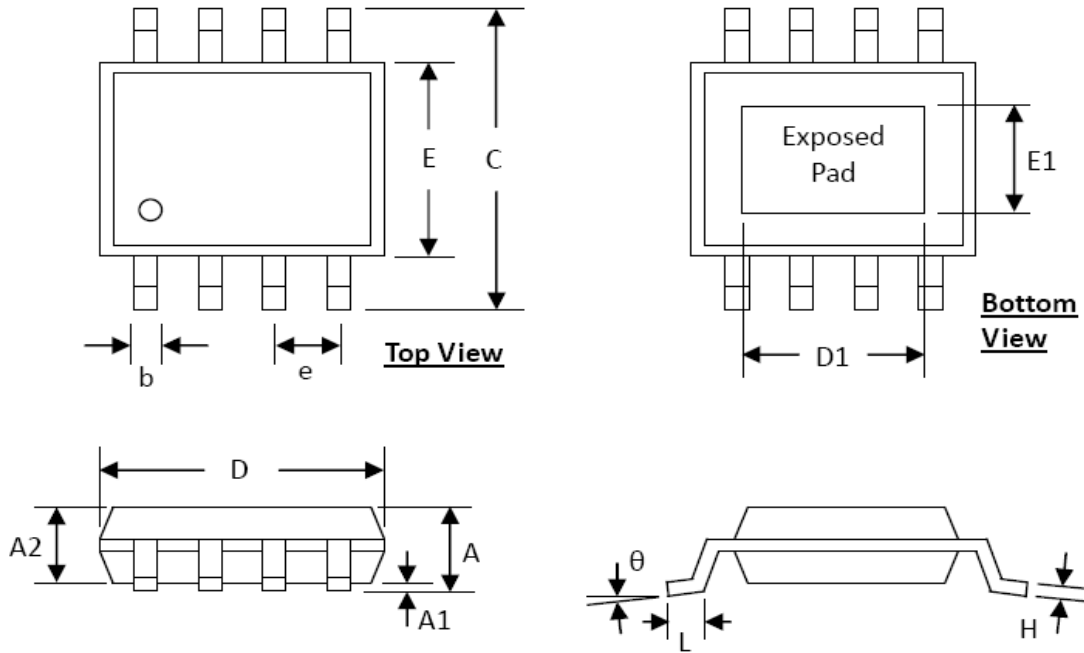

SYMBOLS	DIMENSION (MM)		DIMENSION (INCH)	
	MIN	MAX	MIN	MAX
A	1.30	1.70	0.051	0.067
A1	0.00	0.15	0.000	0.006
A2	1.25	1.52	0.049	0.060
b	0.33	0.51	0.013	0.020
C	5.80	6.20	0.228	0.244
D	4.80	5.00	0.189	0.197
D1	3.15	3.45	0.124	0.136
E	3.80	4.00	0.150	0.157
E1	2.26	2.56	0.089	0.101
e	1.27 BSC		0.050 BSC	
H	0.19	0.25	0.0075	0.0098
L	0.41	1.27	0.016	0.050
$\theta$	0°	8°	0°	8°